



ecoflame 

EcoDesign 2022 compliant

# Designed to Perform, Built to Last

Explore the ecoflame range



**ecoflame 1**  
Wood & Multi-fuel  
- Page 04 -



**ecoflame 2 Mini**  
Wood & Multi-fuel  
- Page 06 -



**ecoflame 2**  
Wood & Multi-fuel  
- Page 08 -



**ecoflame 2 Wide**  
Wood & Multi-fuel  
- Page 10 -



**ecoflame 1**  
Wood & Multi-fuel  
- Page 12 -



**ecoflame 5 Ped**  
Wood & Multi-fuel  
- Page 14 -



**ecoflame 5D**  
Wood & Multi-fuel  
- Page 16 -



**ecoflame 5LS**  
Wood & Multi-fuel  
- Page 18 -



**ecoflame Luxe 5**  
Wood & Multi-fuel  
- Page 20 -



**ecoflame Luxe 8**  
Wood & Multi-fuel  
- Page 22 -



**Chambers, Beams & Hearths**  
- Page 23 & 24 -



**ecoflame**  1

*Warmth That Lasts*

# ecoflame 1

## Multi-fuel Stove

A reliable and well-balanced 5kW multi-fuel stove designed for everyday heating. The Ecoflame 1 combines a durable steel body with a cast iron door and a large viewing window, creating a warm focal point in any room. Simple air controls allow you to fine-tune performance for efficient, consistent heat.



  
**5kW**  
Heat Output

  
**80.7**  
Efficiency

  
**A+**  
Energy Rating

  
**EcoDesign 2022**  
Compliant

## Key Features

- Flue Size: 125mm
- Weight: 65kg
- Fuel Type: Wood & Multi-fuel
- 10-year stove body warranty
- Steel body with cast-iron door
- Precise burn control for efficient fuel use
- DEFRA approved, for smoke-controlled areas
- Log Store Version Available

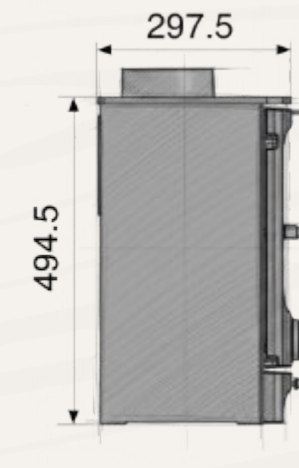
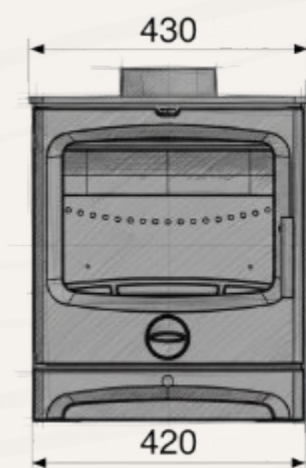
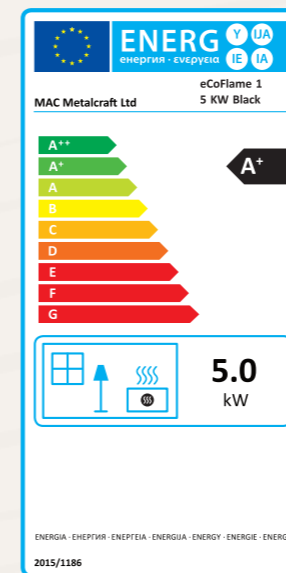



# ecoflame 2 Mini

## Multi-fuel Stove

Compact in size but strong in performance, the Ecoflame 2 Mini is designed for smaller rooms where space is at a premium. Its clean proportions, large viewing window, and precise air controls make it easy to achieve comfortable, efficient heat without compromise.



**4.1kW**  
Heat Output



**77.1**  
Efficiency



**A**  
Energy Rating



**EcoDesign 2022**  
Compliant

## Key Features

- Flue Size: 125mm
- Weight: 50kg
- Fuel Type: Wood & Multi-fuel
- 10-year stove body warranty
- Steel body with cast-iron door
- Airwash system
- Precise burn control for efficient fuel use
- DEFRA approved, for smoke-controlled areas

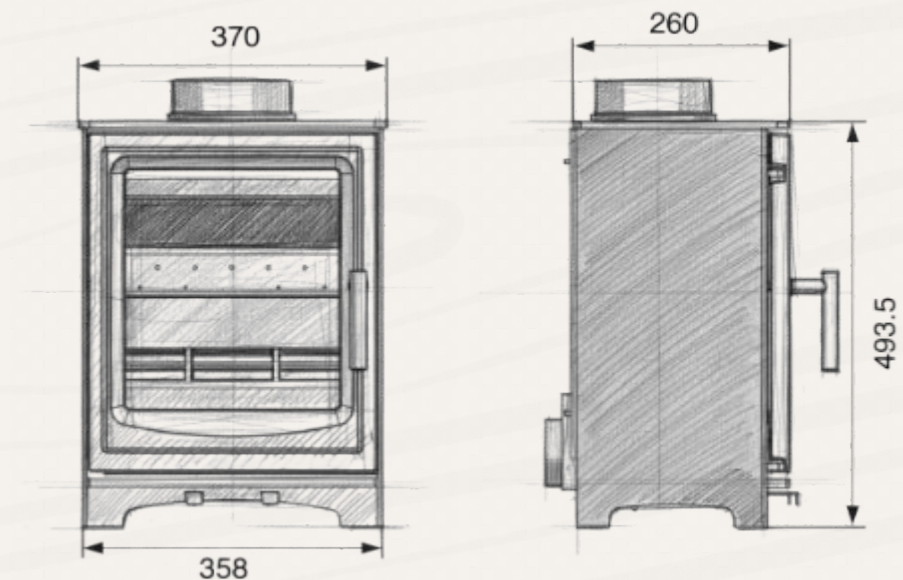
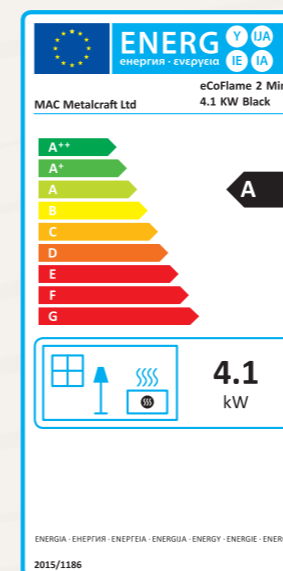

**ecoflame 2 Mini**  
*Performance You Can Rely On*



**ecoflame**  2

*Efficiency Without Compromise*

# ecoflame 2

## Multi-fuel Stove

The Ecoflame 2 offers a refined balance of efficiency and control. Built for dependable 5kW output, it features smooth air regulation and a clear flame view, making it a practical choice for modern homes. Compatible with a direct air kit, it's well suited to newer, airtight properties.



 <b>5kW</b> <i>Heat Output</i>	 <b>82.5</b> <i>Efficiency</i>	 <b>A+</b> <i>Energy Rating</i>	 <b>EcoDesign 2022</b> <i>Compliant</i>
-------------------------------------------------------------------------------------------------------------------------	-------------------------------------------------------------------------------------------------------------------------	--------------------------------------------------------------------------------------------------------------------------	----------------------------------------------------------------------------------------------------------------------------------

## Key Features

- Flue Size: 125mm
- Weight: 65kg
- Fuel Type: Wood & Multi-fuel
- 10-year stove body warranty
- Steel body with cast-iron door
- Direct air kit compatible
- DEFRA approved, for smoke-controlled areas
- Precise burn control for efficient fuel use

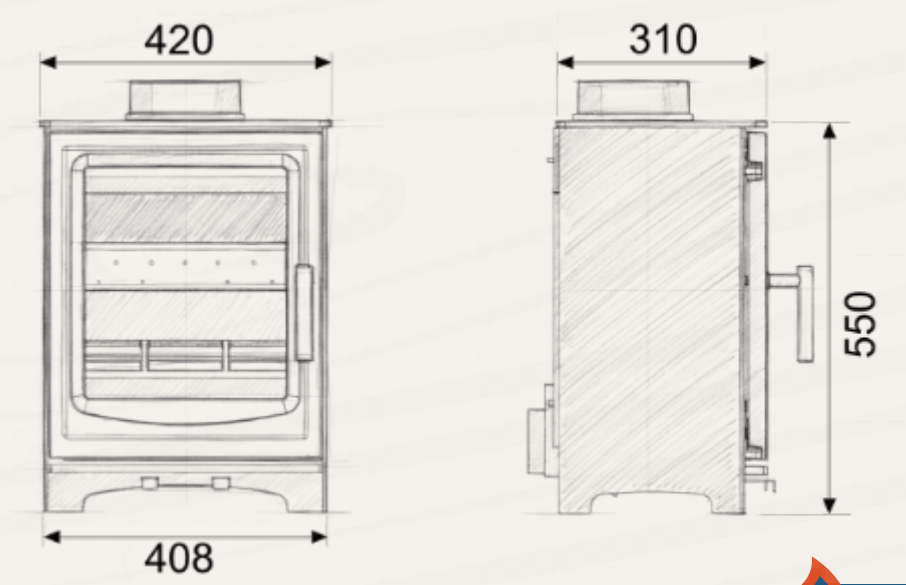
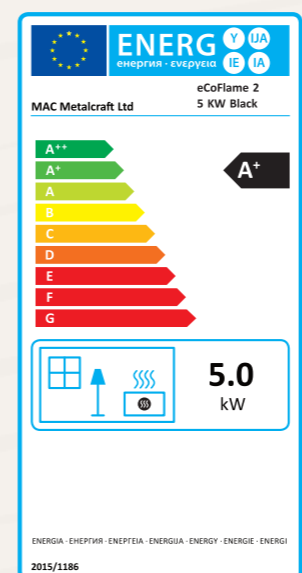



# ecoflame 2 Wide

*Engineered for Reliability*

## ecoflame 2 Wide

### Multi-fuel Stove

Designed to maximise flame presence, the Ecoflame 2 Wide features a broader viewing window that enhances the visual impact of the fire. Delivering the same dependable 5kW output, it's ideal for those who want a wider, more immersive focal point without increasing heat output.



  
**5kW**  
Heat Output

  
**81.3**  
Efficiency

  
**A+**  
Energy Rating

  
**EcoDesign 2022**  
Compliant

### Key Features

- Flue Size: 125mm
- Weight: 80kg
- Fuel Type: Wood & Multi-fuel
- 10-year stove body warranty
- Steel body with cast-iron door
- 8kW option available for larger spaces
- DEFRA approved, for smoke-controlled areas
- Direct air kit compatible

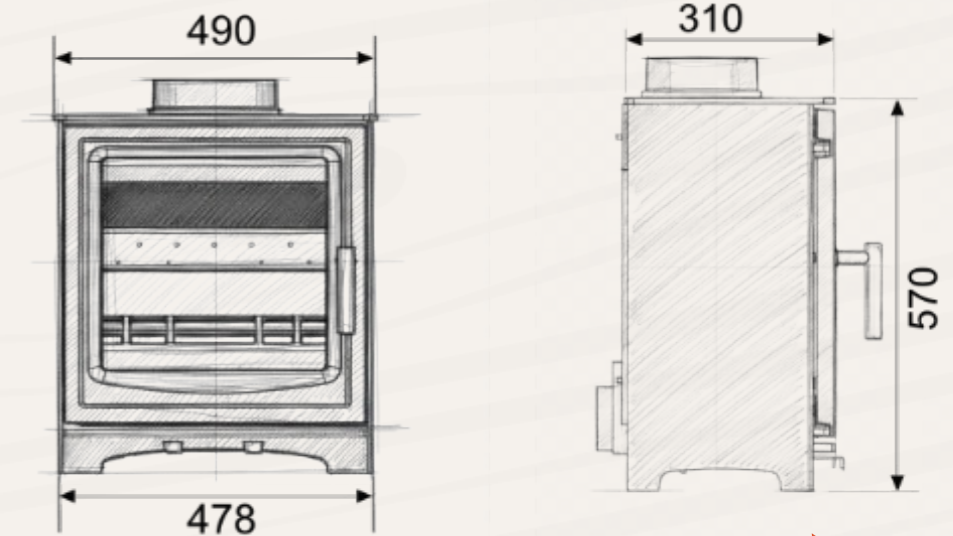
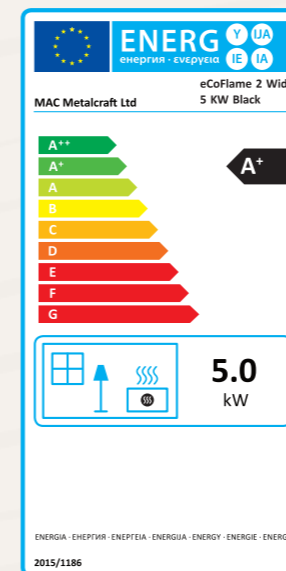



# ecoflame 4i

## Multi-fuel Stove

Built to integrate seamlessly into a standard fireplace opening, the Ecoflame 4i inset stove offers a clean, built-in look with reliable 5kW performance. Its cassette-style construction improves heat efficiency while maintaining a sleek, contemporary finish.



  
**5kW**  
Heat Output

  
**83.7**  
Efficiency

  
**A+**  
Energy Rating

  
**EcoDesign 2022**  
Compliant

## Key Features

- Flue Size: 125mm
- Weight: 72kg
- Fuel Type: Wood & Multi-fuel
- 10-year stove body warranty
- Steel body with cast-iron door
- Inset cassette design (box-in-box)
- Precise burn control for efficient fuel use
- DEFRA approved, for smoke-controlled areas

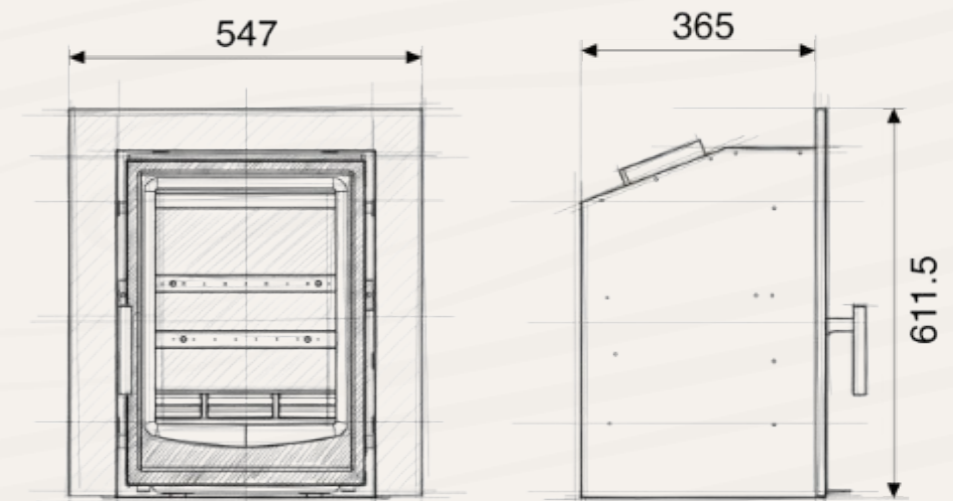
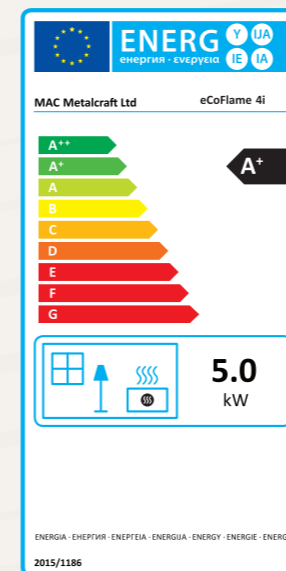

**ecoflame 4i**  
*Quality You Can Depend On*



# ecoflame 5 Ped

## Wood Burning Stove

Elevated for both style and practicality, the Ecoflame 5 Ped features a pedestal base that raises the firebox for improved visibility and ease of use. Its cylindrical form and modern profile make it a striking addition to modern interiors.



 <p><b>5kW</b> Heat Output</p>	 <p><b>77.7</b> Efficiency</p>	 <p><b>A</b> Energy Rating</p>	 <p><b>EcoDesign 2022</b> Compliant</p>
-----------------------------------------------------------------------------------------------------------------------	-----------------------------------------------------------------------------------------------------------------------	-----------------------------------------------------------------------------------------------------------------------	--------------------------------------------------------------------------------------------------------------------------------

### Key Features

- Flue Size: 125mm
- Weight: 80kg
- Fuel Type: Wood Only
- 10-year stove body warranty
- Steel body with cast-iron door
- Direct air kit compatible
- Precise burn control for efficient fuel use
- DEFRA approved, for smoke-controlled areas

**ecoflame 5 Ped**  
*Designed for Modern Living*

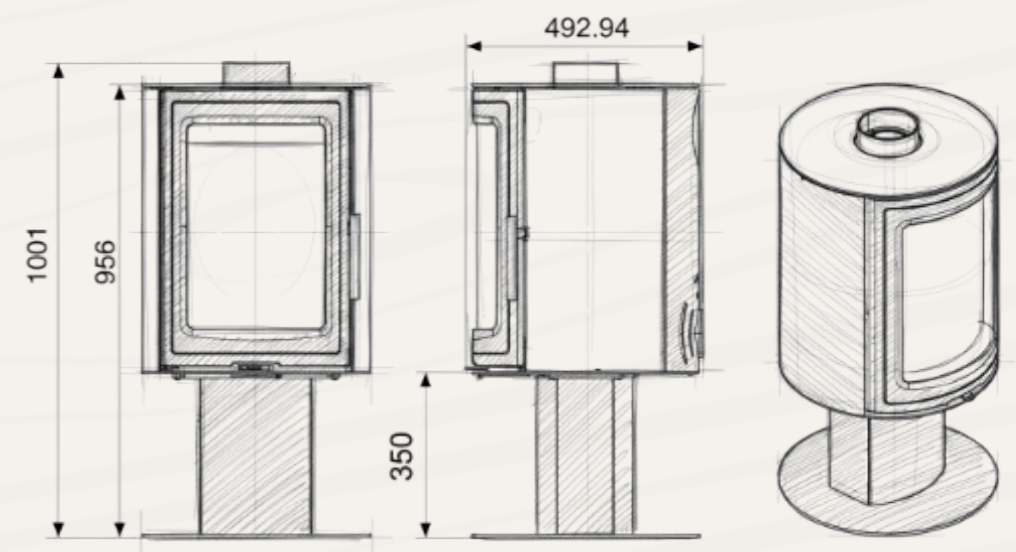
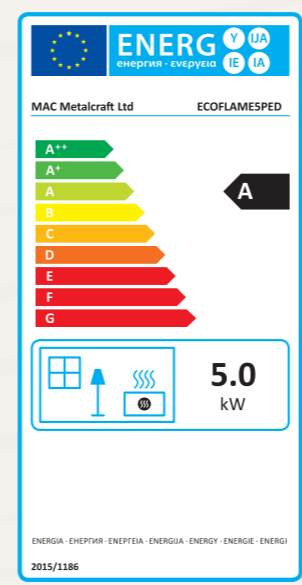



# ecoflame 5 Ped

## Wood Burning Stove

A distinctive cylindrical stove designed for modern living, the Ecoflame 5D combines clean lines with everyday functionality. The integrated storage compartment keeps essential tools close to hand, while the elevated fire view creates a strong visual centrepiece.



  
**5kW**  
Heat Output

  
**77.7**  
Efficiency

  
**A**  
Energy Rating

  
**EcoDesign 2022**  
Compliant

## Key Features

- Flue Size: 125mm
- Weight: 90kg
- Fuel Type: Wood Only
- 10-year stove body warranty
- Steel body with cast-iron door
- Direct air kit compatible
- Precise burn control for efficient fuel use
- DEFRA approved, for smoke-controlled areas

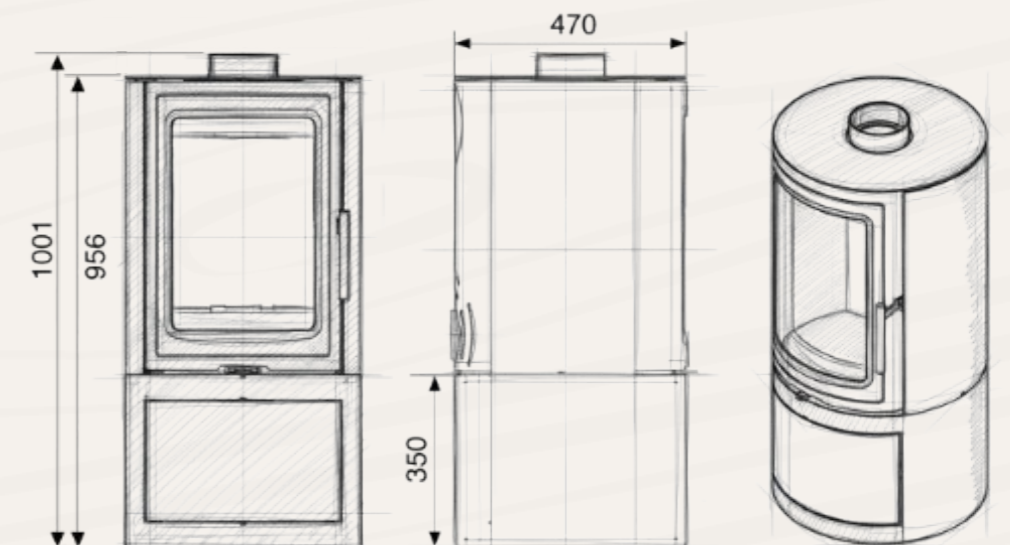
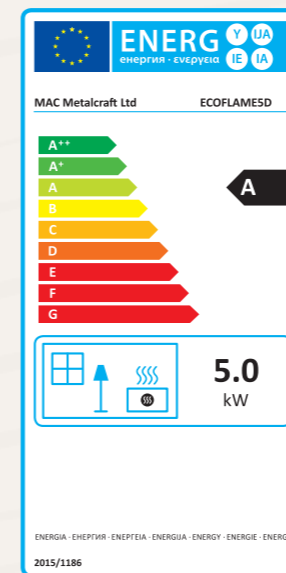

**ecoflame 5D**  
*Built for Everyday Heating*



# ecoflame 5LS

## Wood Burning Stove

Combining efficient heating with practical storage, the Ecoflame 5LS features an integrated log store that keeps fuel neatly organised. Its tall, balanced design makes it ideal for creating a statement while maintaining everyday usability.



 <p><b>5kW</b> Heat Output</p>	 <p><b>77.7</b> Efficiency</p>	 <p><b>A</b> Energy Rating</p>	 <p><b>EcoDesign 2022</b> Compliant</p>
-----------------------------------------------------------------------------------------------------------------------	-----------------------------------------------------------------------------------------------------------------------	-----------------------------------------------------------------------------------------------------------------------	--------------------------------------------------------------------------------------------------------------------------------

### Key Features

- Flue Size: 125mm
- Weight: 90kg
- Fuel Type: Wood Only
- 10-year stove body warranty
- Steel body with cast-iron door
- Direct air kit compatible
- Precise burn control for efficient fuel use
- DEFRA approved, for smoke-controlled areas

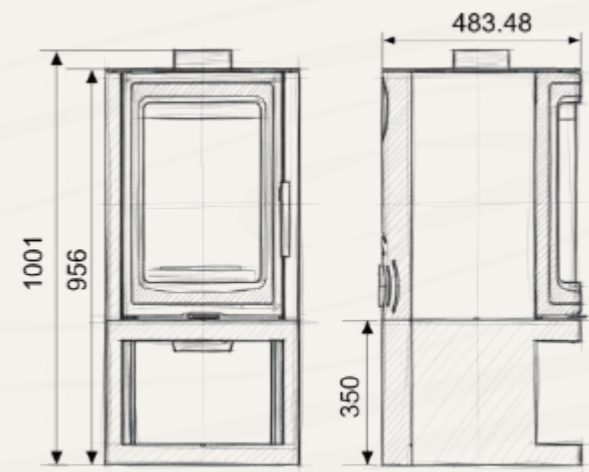
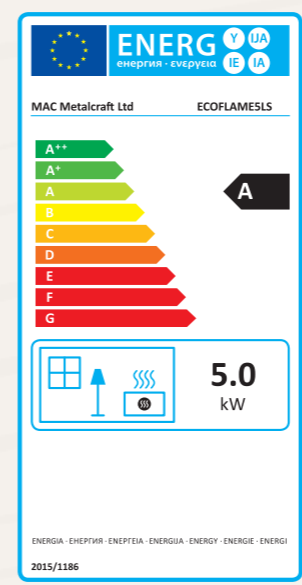

**ecoflame 5LS**  
*Comfort You Can Count On*



# ecoflame Luxe 5

## Multi-fuel Stove

The Ecoflame Luxe 5 is designed to bring a more traditional stove aesthetic together with modern performance. Its classic proportions and detailed styling make it well suited to period properties, while delivering efficient, controllable heat for everyday use.



  
**5kW**  
Heat Output

  
**79.9**  
Efficiency

  
**A**  
Energy Rating

  
**EcoDesign 2022**  
Compliant

## Key Features

- Flue Size: 125mm
- Weight: 80.3kg
- Fuel Type: Wood & Multi-fuel
- 10-year stove body warranty
- Steel body with cast-iron door
- Direct air kit compatible
- Precise burn control for efficient fuel use
- DEFRA approved, for smoke-controlled areas

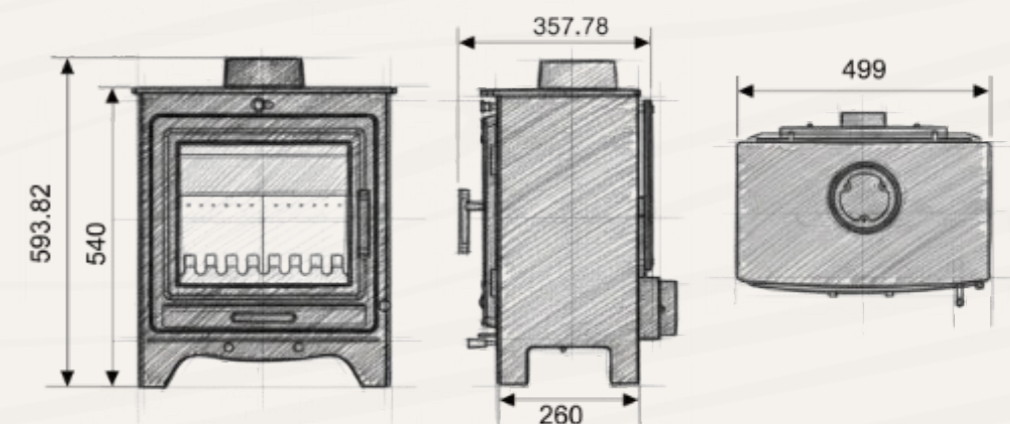
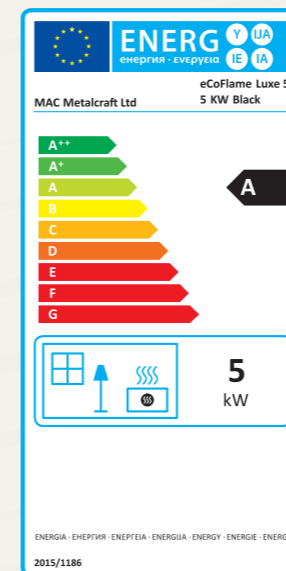

ecoflame  Luxe 5

*Built Around Real Homes*



# ecoflame Luxe 8

## Multi-fuel Stove

Built for larger spaces, the Ecoflame Luxe 8 offers increased presence and a wider flame view. Its durable construction and traditional styling make it a natural choice for rooms where both heat output and visual impact are needed.



  
**8kW**  
Heat Output

  
**79**  
Efficiency

  
**A**  
Energy Rating

  
**EcoDesign 2022**  
Compliant

## Key Features

- Flue Size: 125mm
- Weight: 101.7kg
- Fuel Type: Wood & Multi-fuel
- 10-year stove body warranty
- Steel body with cast-iron door
- Direct air kit compatible
- Precise burn control for efficient fuel use
- DEFRA approved, for smoke-controlled areas

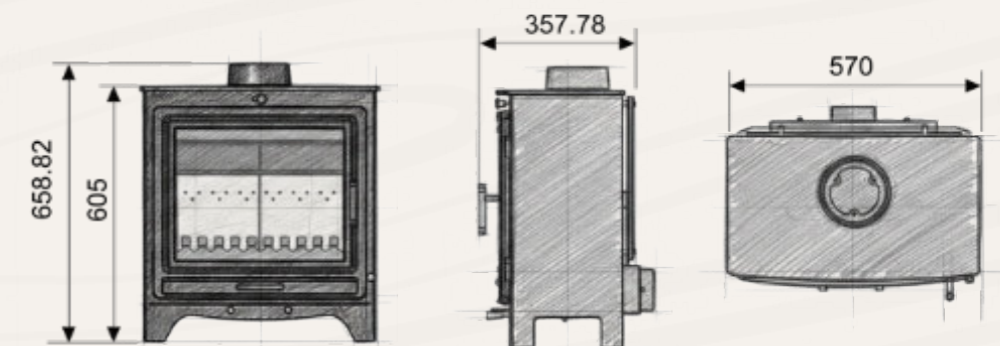
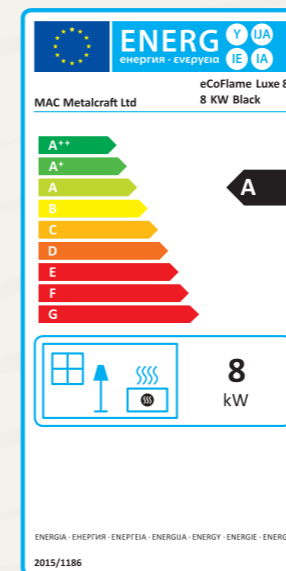

**ecoflame  Luxe 8**  
*Built for Daily Comfort*

# Popular Chambers, Hearths and Beams

Our full range of options can be found on our website: [www.ecoflame.co.uk](http://www.ecoflame.co.uk)



Black Block Slate

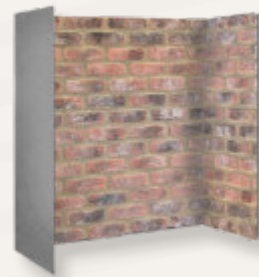

Antique Rustic Brick



Oyster Split Face Slate



Cubics Multi



Nut Black Acoustic

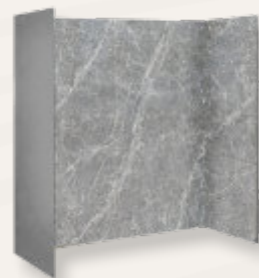

Smoke Grey Stone



Tiled Lume Blue



Frugru Black Acoustic



London Charcoal Herringbone



Silver White Split Face Slate

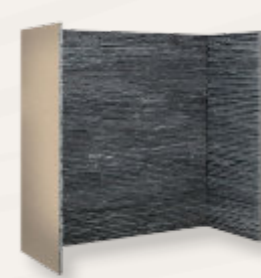

Charcoal Slate Waterfall



London Sunset Red Brick Bond



Light Oak



Dark Oak



Antique Oak



Rustic Dark Oak



Rustic Natural Oak



Heritage Natural Oak



Harlequin Blue



Lume Blue



Mocha Riven Slate Effect



Primitive Grey



Black Riven Slate Effect

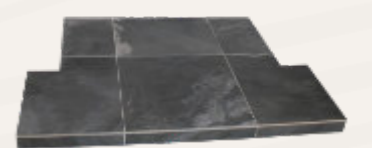

Primitive Anthracite

The logo for Ecoflame, featuring the word "eco" in green and "flame" in blue, with a stylized flame icon to the right.

eco**flame**

[www.ecoflamestoves.co.uk](http://www.ecoflamestoves.co.uk)

[info@ecoflamestoves.co.uk](mailto:info@ecoflamestoves.co.uk)

01709 570 563

